

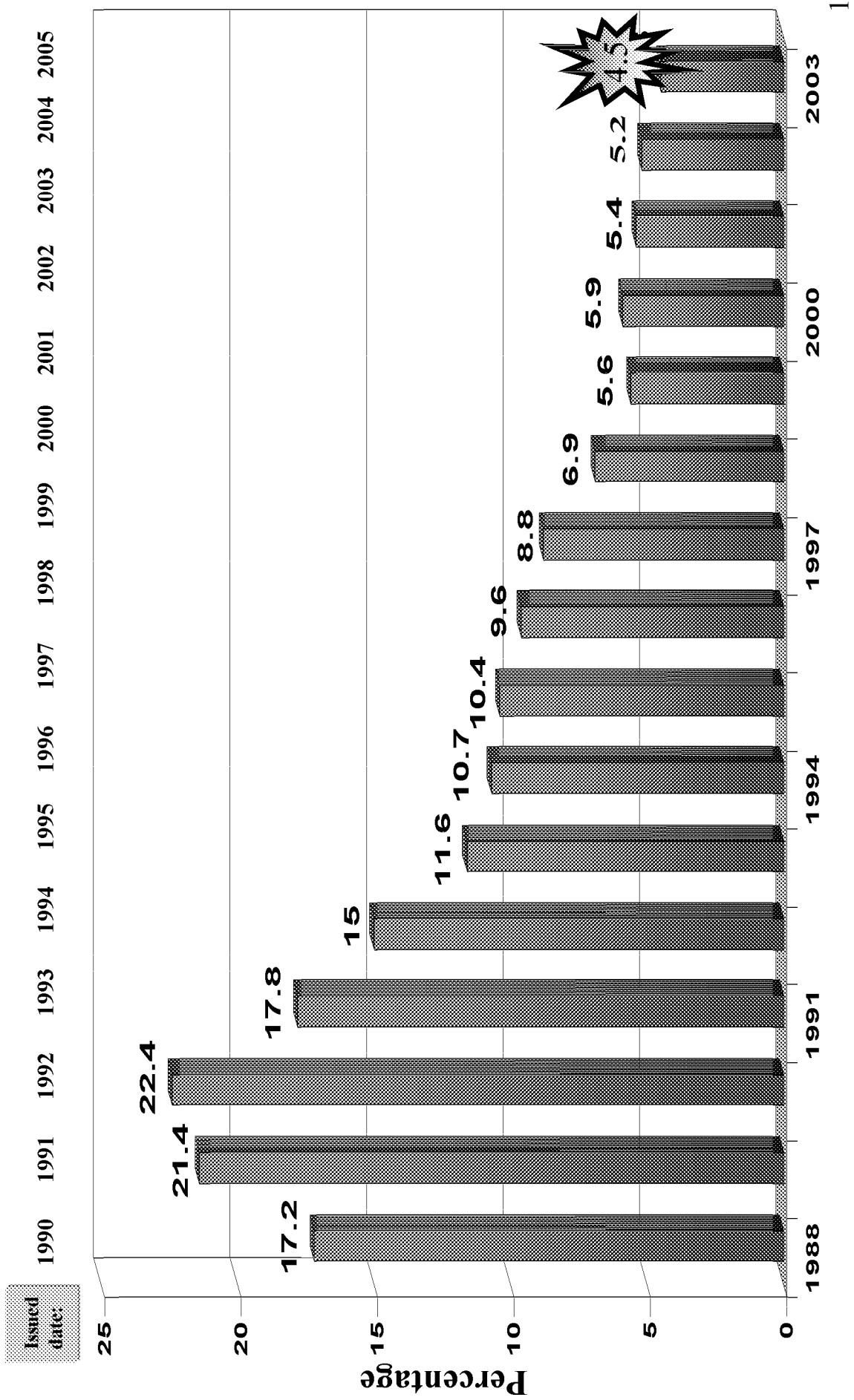

National Student Loan Cohort Default Rates





Schools Subject to Sanctions

Issued
date:

1993 1994 1995 1996 1997 1998 1999 2000 2001 2002 2003 2004 2005

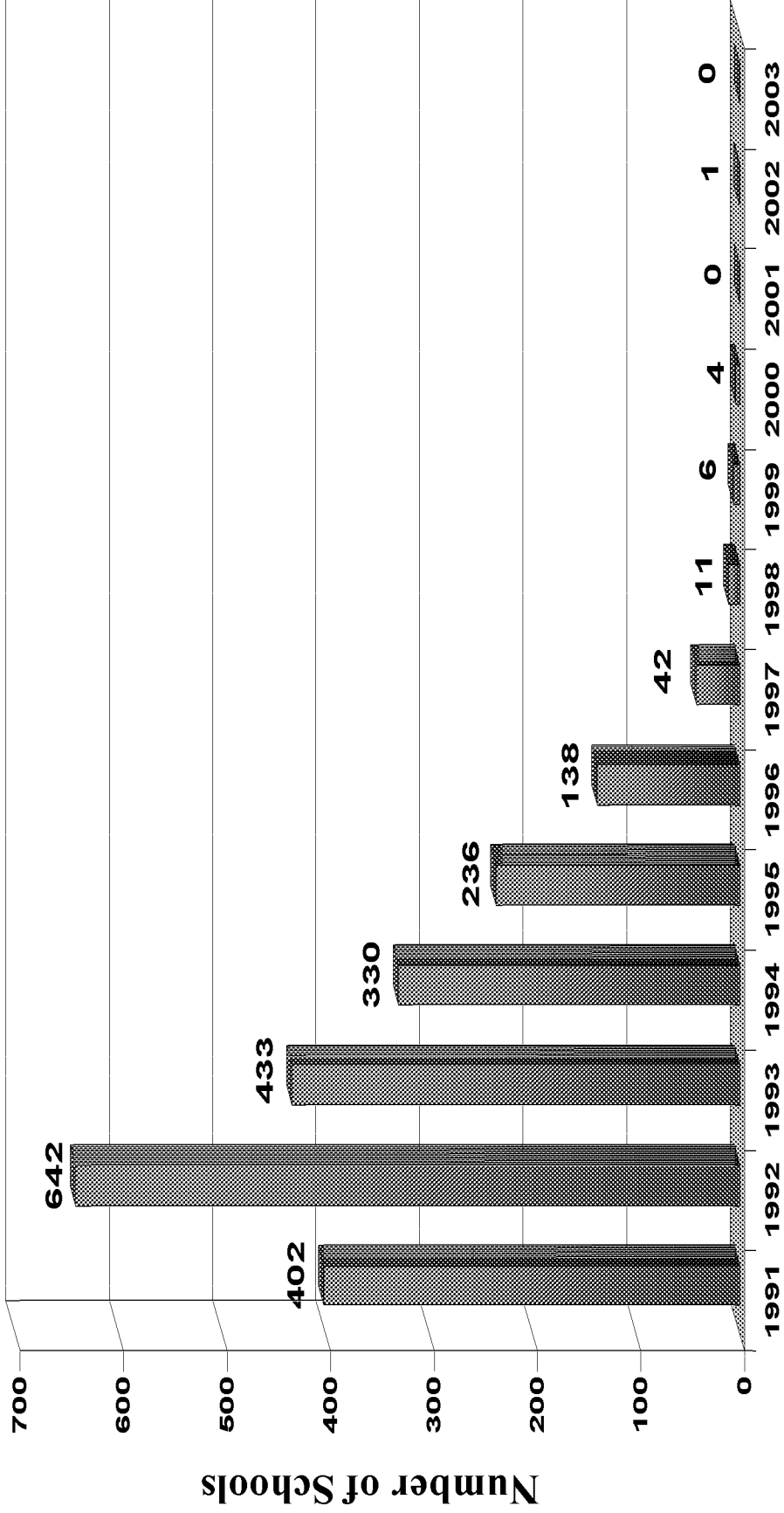

The school numbers are pre-appeal and include only schools impacted by the three years of 25% or greater sanction. A school can be on extended sanction and is therefore reflected in multiple year counts. Since 1991, 1,161 unique schools were sanctioned under the three years of 25% or greater sanction.

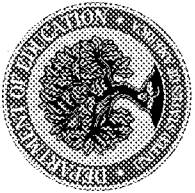

Improving Borrower Accountability

Communication

- Increased Borrower Contacts
- Conference Sessions on Default Reduction

Technical Assistance

- Cohort Default Rate Guide
- On-site School Visits
- National Handbook of Best Practices
- FSA Assessments
- Sample Default Management Plan

Risk Analysis and Assessment

- Data Mining and Portfolio Analysis
- Portfolio Risk Management Group

Aversion Tools

- Improved Entrance/Exit Counseling
- Flexible Repayment Options
 - Customized Repayment Plans
 - Electronic Billing and Payment
- Late Stage Delinquency Assistance

Program Integrity

- Strategic Identification and Intervention

Improved Borrower
Accountability



Schools

Lenders/Service
Guaranty Agencies

Department of
Education



Improving Program Integrity

Eligible Borrowers	Repay Loans	Collect Debt
SSN Match	Default Prevention Plan	Directory of New Hires
SSS Match	VFA	Wage Garnishment
DHS (non-citizen status) Match	FSA Assessment	Treasury Offset
NSLDS Match	Technical Assistance EDA	Performance-based Contracts
Flexible Repayment Options		



FSA

School

GA

Lender

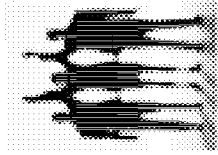

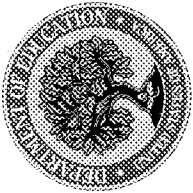

Federal Family Education Loan and Federal Direct Loan Cohort Default Rates

Institutional Default Rate Reduction Initiative Comparative Comparison of FY 2001, FY 2002, and FY 2003 Cohort Default Rates

# of schools	Fiscal Year 2001 Official			Fiscal Year 2002 Official			Fiscal Year 2003 Official				
	Borrower Default Rate (%)	# of Borrowers Defaulted	# of Borrowers Entered Repayment	# of schools	Borrower Default Rate (%)	# of Borrowers Defaulted	# of Borrowers Entered Repayment	# of schools	Borrower Default Rate (%)	# of Borrowers Defaulted	# of Borrowers Entered Repayment
1,713	5.3%	71,077	1,316,719	1,681	5.1%	66,297	1,295,318	1,663	4.3%	59,460	1,356,086
168	7.2%	387	5,366	165	6.7%	396	5,851	159	5.8%	359	6,182
930	8.6%	26,148	301,125	908	8.5%	25,695	299,379	895	7.6%	25,259	328,730
615	4.4%	44,542	1,010,228	608	4.0%	40,206	990,088	609	3.3%	33,842	1,021,174
1,888	3.5%	23,360	667,002	1,837	3.2%	22,019	669,099	1,812	2.8%	19,523	695,576
83	9.3%	263	2,810	65	9.7%	289	2,954	55	7.9%	265	3,326
273	6.8%	1,353	19,719	248	6.1%	1,348	21,959	247	6.3%	1,477	23,160
1,532	3.3%	21,744	644,473	1,524	3.1%	20,382	644,186	1,510	2.6%	17,781	669,090
2,215	9.0%	35,485	391,531	2,000	8.7%	37,269	423,631	1,950	7.3%	36,477	493,895
1,335	10.8%	11,090	102,569	1,131	10.1%	11,092	108,748	1,054	7.9%	9,302	117,166
704	9.3%	14,606	157,045	681	9.2%	14,801	160,432	688	8.0%	14,469	179,553
176	7.4%	9,789	131,917	188	7.3%	11,376	154,451	208	6.4%	12,706	197,176
420	2.3%	113	4,905	436	2.0%	111	5,434	411	1.8%	108	5,844
4	0.1%	1	584	1	0.0%	0	294	1	0.0%	0	31
6,240	5.4%	130,036	2,380,741	5,955	5.2%	125,696	2,393,776	5,837	4.5%	115,568	2,551,432

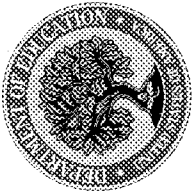

FSA Overview

Scope of Operations – Fiscal Year 2004

- 14 million aid applications
- 10 million aid recipients
- \$70 billion delivered in total new federal aid
- \$44 billion delivered in consolidation loans
- 35 million inbound and outbound customer service phone calls
- 27 million Direct Loan borrower payments processed
- 20 billion hits to FSA Web sites
- 80+ million pieces of mail sent out by FSA during the annual cycle

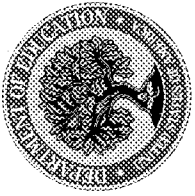

FSA Overview

Current Student Loan Portfolio - Fiscal Year 2004

- 25 million borrowers with outstanding loans
 - \$360 billion in outstanding loans
- Includes:
- Direct Loans held by ED
 - Federal Family Education Loan Program (FFELP) loans held by lenders
 - Defaulted FFELP loans held by guaranty agencies (GAs)
 - Defaulted loans (all programs) held by ED
 - Perkins Loans held by schools

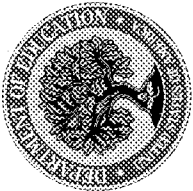

Programs and Statistics

Total Federal Student Loan Portfolio - Fiscal Year 2004

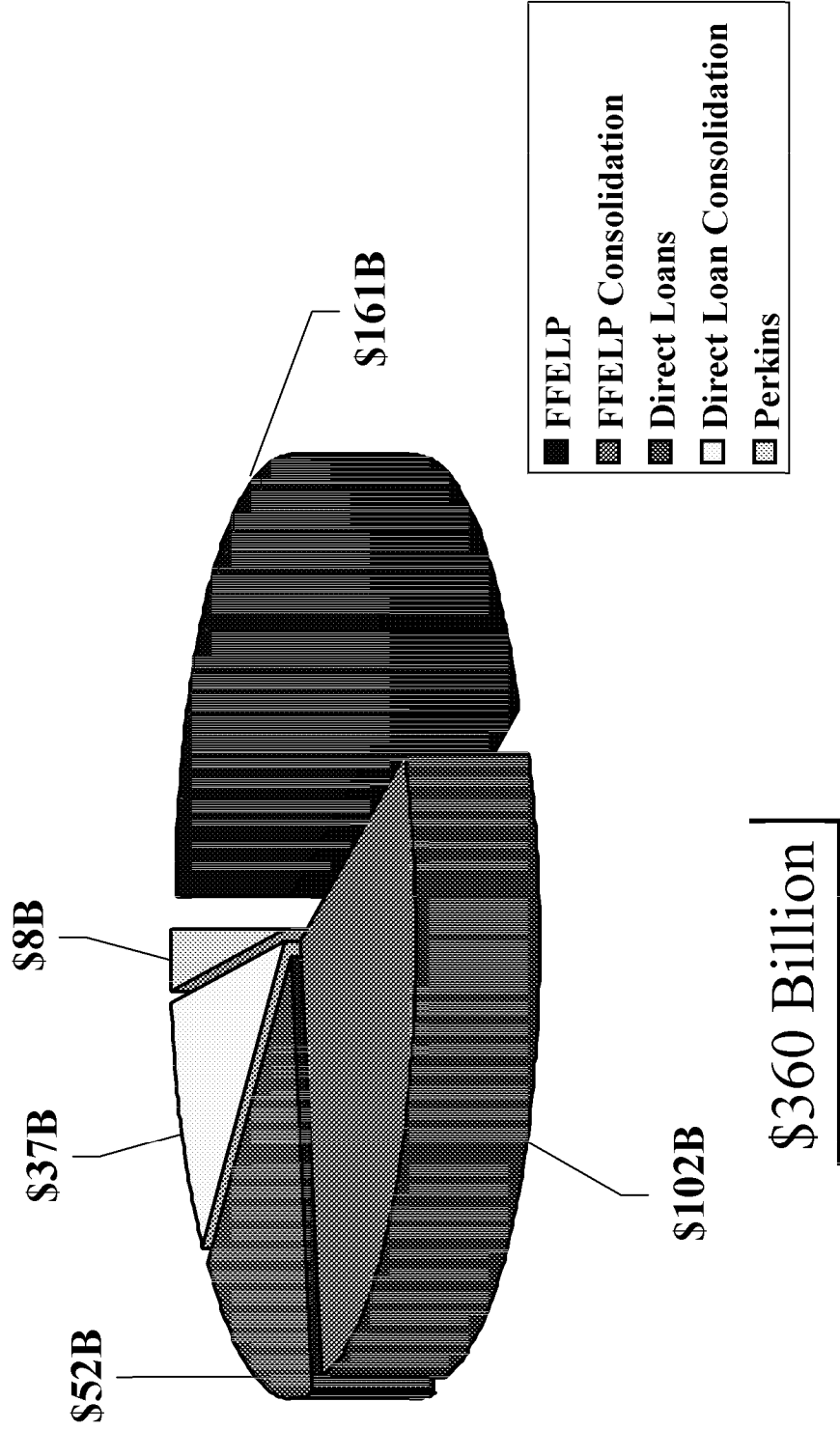



Programs and Statistics

Distribution of Aid Types - Fiscal Year 2004

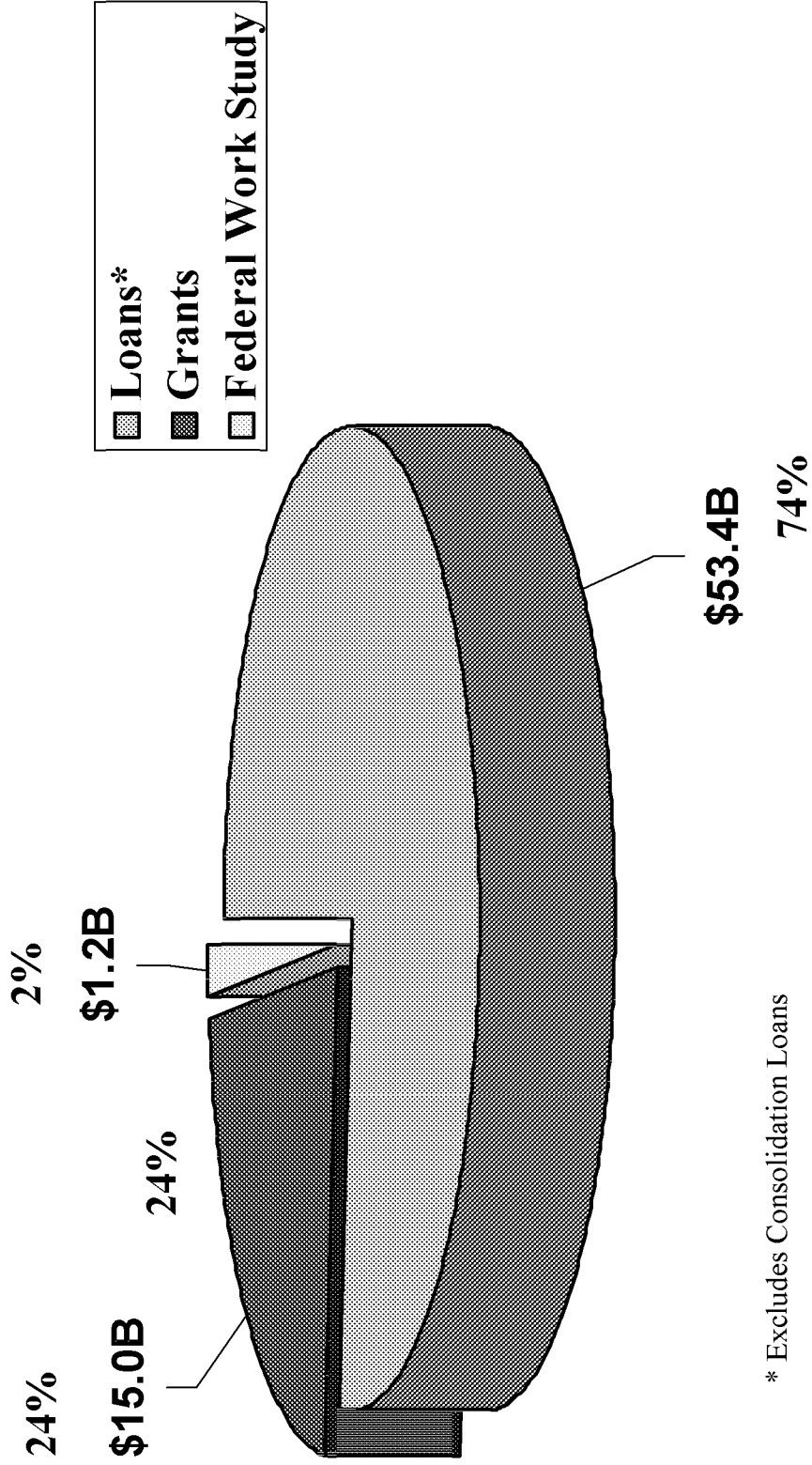

* Excludes Consolidation Loans